

2018 Hong Kong
International Lighting Fair (Autumn)

2019 NEW EDITION PART 1

LED PLANT GROW LIGHT · EXTERIOR LIGHT
INTERIOR LIGHT · NOVELTY



HOME RESOURCE IND. CO., LTD.
Home Resource LEDS The World



OUR VISION

◆ To Illuminate Every Part of the World ◆

OUR MISSION

- ◆ To be the leading lighting company in Taiwan and China
- ◆ To be the best at what customers value most
- ◆ To exceed customers expectation
- ◆ Treat staffs & customers & substructures as partnership
- ◆ Enjoy work as part of life

OUR CORE COMPETENCE

- ◆ Integrity
- ◆ Innovation
- ◆ Profession
- ◆ Passion
- ◆ Efficiency
- ◆ Responsibility
- ◆ Teamwork



President's Message

Sam Chen Ph. D

President of Home Resource

- Chairman of TLFEA (2004-2007)
TLFEA: Taiwan Lighting Fixture Export Association
- Director of CEECA and LABC
CEECA: The Central, Eastern Europe and CIS Association
LABC: Latin American Business Council
- Vice Chairman of Taiwan Investors Association in Zhongshan

Since its establishment in 1988, Home Resource Ind. Co., Ltd. has been dedicated to production and development of lighting products for three decades.

We would like to take this opportunity to express our sincere appreciation for your fully supports and concerns over the past 30 years.

With years of efforts on upgrading production capability and capacity, Home Resource has grown into a consummate manufacturer of lightings on OEM (original equipment manufacturing) and ODM (original design manufacturing) basis. Globally reputed R&D talent has also helped Home Resource to enhance popularity and recognition of its own-brand products in recent years.

In addition to existing branches, Home Resource has opened a constructed plant of 26,000 square meters in China (Zhong Shan City, Guangdong Province), which employs advanced production equipment to assure even shorter delivery and more considerate services for clients than before.

We strive for success not only in having determination and courage, but also developing innovative products and marketing intelligence base on our core competence: innovation, efficiency, integrity and passion. Home Resource will definitely get hold of past success to carry on growing continuously in the lighting territory now and then. Let's witness the brand new, prosperous Home Resource to achieve an even higher peak of success in the coming future.

David Chen
General Manager



Home Resource was established in 1988. Since then, the company has developed into one of the most professional lighting manufactures in Taiwan and Mainland China.

Home Resource/Green Resource would like to express our sincere thanks to all customers, parts sub-contractors and every one of our employees. It is their continuing support and hard work that has allowed Home Resource/Green Resource to grow as rapidly as they have been able to. HR&GR will continue to make even greater efforts in the future.

Other than a self-support manufacturer, through a presence in Ningbo and Zhongshan and 50 employees, Home Resource also operates a sourcing network of two offices in China.

We strive to attain a position of long-term, sustainable pre-eminence in the lighting field "lighting up" both our customers and ourselves.

We look forward to working with you all continuously to create a brilliant future.



China Factory - 26,000m² (Zhongshan City, Guangdong Province)

Home Resource's products are designed and manufactured by its own factory (Green Resource) Sited in Zhongshan, China.



HOME RESOURCE

has received the following awards:

Design Awards:



■ Good Design Product of Taiwan



■ Red Dot Award of Germany



L: Sam Chen
(President of Home Resource Co.,)
R: Alfred Albrecht, TUVPS
(GS Testing & Certification)



L: Sam Chen
(President of Home Resource Co.,)
R: P. K. Chiang
(Minister of Economic Department Taiwan)

■ Awarded from TUVPS as one of the Top 5 Golden Clients in Asia (2003)

■ Being as Chairman of Taiwan Lighting Association in 2004



L: Jack Chen
(Former President of HR / GR)
R: Representative of Senior Group

■ Award from Senior Group Towards Annual Charity Donation

1. Red Dot Design Award: product design 2008, Germany. National Excellent Lighting Quality Award in 1998 and 2011 (Japan).
2. In 1995, HR being the 1st Taiwanese company in receipt of NEMKO, SEMKO, DEMKO and FI Certificates.
3. Excellent Quality Award, Spain, 1996.
4. Awarded as one of the best "ISO 9001:2000" companies listed as members of KEMA organization in 1999, 2004 and 2010.
5. National Quality Award in Taiwan in 2002, 2003, 2004, 2005, 2006 and 2014.
6. The Most Popular Product Award in 2009 from Taiwan External Trade Development Council.
7. Good Design Product, Taiwan, since 2008. The Best Innovation Award of Taiwan Lighting Association in 2009.
8. Association in 1993, 1994, 2002, 2005, 2008, 2012 and 2015.

Index

LED Plant Grow Light



• PNLED-137
Page01



• PNLED-140
Page01



• PNLED-142
Page02-03



• PNLED-142WLK
Page02-03



• PNLED-142HG
Page02-03



• PNLED-150A
Page04-05



• PNLED-150WLK
Page04-05



• PNLED-150HG
Page04-05



• PNLED-144-2
Page06-07



• PNLED-142-2
Page06-07



• PNLED-150-2
Page06-07



• PNLED-18SP
Page08-09



• PNLED-142SP
Page08-09



• PNLED-145SP
Page08-09

Exterior Light



• FLED-701
Page10



• FLED-701S
Page10



• FLED-702
Page11



• FLED-702S
Page11



• FLED-735
Page12



• FLED-735S
Page12



• ELED-281
Page13



• ELED-121
Page14



• ELED-122
Page14



• ELED-123
Page14



• ELED-124
Page15



• ELED-124S
Page15



• ELED-125
Page16-17



• ELED-125S
Page16-17



• GPLLED-125
Page16-17



• GPLLED-125S
Page16-17



• EL-126
Page18



• GPL-126
Page18

Index

Interior Light



• TCLED-221
Page19



• TLED-113
Page20



• TLED-114
Page21



• TLED-120
Page22-23



• TLED-121
Page22-23



• WLED-221
Page24-25



• WLED-222
Page24-25



• WLED-224
Page26-27



• WLED-227
Page26-27



• WLED-225
Page28-29



• WLED-226
Page28-29



• WLED-228
Page30-31



• WLED-228A
Page30-31



• WLED-229
Page30-31



• WLED-229A
Page30-31



• WLED-230
Page30-31



• WLED-230A
Page30-31

Novelty



• ETLED-18BPT1
Page32



• BO-LED74
Page33



• BO-LED026
Page34



• BO-LED121
Page35



• SPK-B016
Page36-37



• SPK-B016U
Page36-37



• KLED-61
Page38-39



• KLED-61A
Page38-39



• MRLED-97
Page40

Let's Make Sweet Homes Together

LED PLANT GROW Light



Material: ABS Body + Plastic Plate

Lamp: 2.5W(Red LED + Blue LED + SMD2835 White 4000K LED)

2 Switches on Base

Switch for PLANT: Red Light and Blue Light

(If the light is not turned off, it will automatically shut down after 12H)

Switch for LAMP: White Light

With 1.2m USB Cable

Color: White / Black

Glass Bucket / Tripod are Optional

IP20

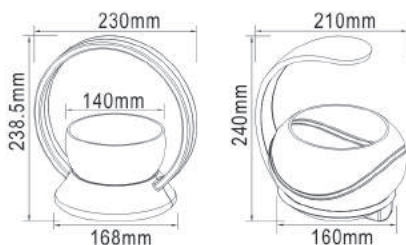

● PNLED-140 (Halo)



● PNLED-137 (Swan)

Tall:

With the essential Red+Blue spectrums, stems will grow taller, and leaves will grow stronger by using it 8 hours a day.

Healthy:

Whatever the weather, plants always receive the lights consistently which makes them grow healthier.

Beautiful:

Switching to general lighting mode, it makes plants prettier and makes surrounding more harmonious.

LED Plant Grow Light-ALFA

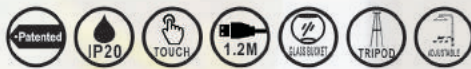

Material: Iron Body + ABS Base + Plastic Plate
Lamp: 5W(Red LED + Blue LED + White 4000K LED)

2 Switches on Base

Switch for PLANT: Red Light and Blue Light
(if the light is not turned off, it will automatically shut down after 12H)

Switch for LAMP: White Light

With 1.2m USB Cable (Table Light)

Finish: White / Black

Glass Bucket / Tripod for Optional
IP20



● PNLED-142

02

Home Resource Ind. Co., Ltd.

Tall:

With the essential Red+Blue spectrums, stems will grow taller, and leaves will grow stronger by using it 8 hours a day.

Healthy:

Whatever the weather, plants always receive the lights consistently which makes them grow healthier.

Beautiful:

Switching to general lighting mode, it makes plants prettier and makes surrounding more harmonious.



With Built-in Driver

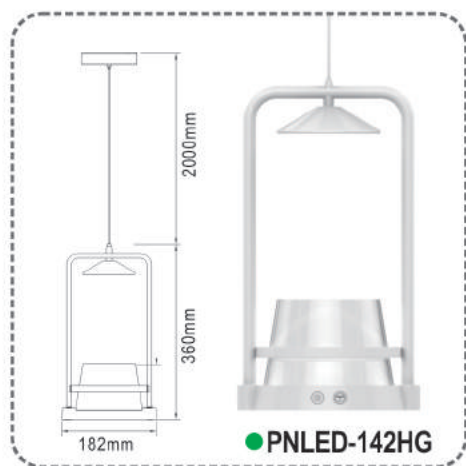

With 2m Cable and Built-in Driver



With 2.6m USB Cable

LED Plant Grow Light - CAGE



Material: Iron Body + ABS Base + Plastic Plate
Lamp: 5W(Red LED + Blue LED + White 4000K LED)

2 Switches on Base

Switch for PLANT: Red Light and Blue Light
(if the light is not turned off, it will automatically shut down after 12H)

Switch for LAMP: White Light

With 1.2m USB Cable (Table Light)

Finish: White / Black

Glass Bucket / Tripod for Optional

IP20

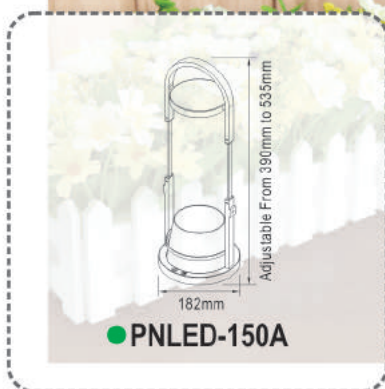

● PNLED-150A

Tall:

With the essential Red+Blue spectrums, stems will grow taller, and leaves will grow stronger by using it 8 hours a day.

Healthy:

Whatever the weather, plants always receive the lights consistently which makes them grow healthier.

Beautiful:

Switching to general lighting mode, it makes plants prettier and makes surrounding more harmonious.



With Built-in Driver

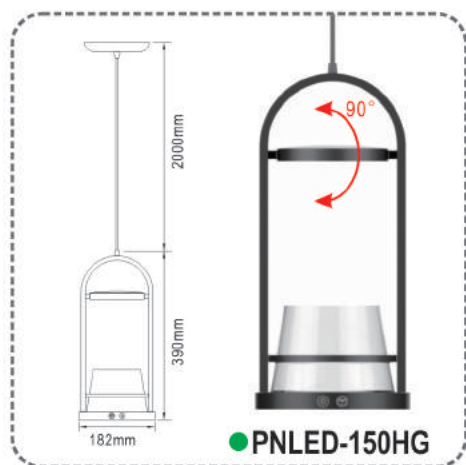

With 2m Cable and Built-in Driver



With 2.6m USB Cable

NEW



LED PLANT GROW Light



Material: Iron + ABS + Steel + Plastic Plate
Lamp: 10W (Red LED + Blue LED + White 4000K LED)
Color: Light Wood + White
With 2 Touch Switches on Base
-Switch for PLANT: Red Light + Blue Light
(automatically shut down after 12 hours)
-Switch for Lamp: White Light
With Height-adjustable Tube
With 1.2m USB Cable

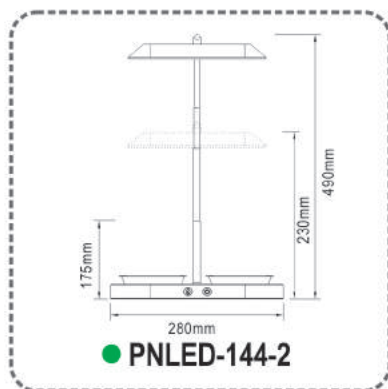

Adjustable from 230mm to 490mm
Without Plastic Pot

06

Home Resource Ind. Co., Ltd.

NEW



Adjustable from 230mm to 490mm
Without Plastic Pot

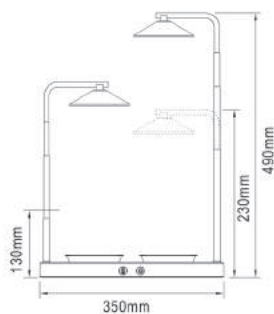

● PNLED-142-2



Adjustable from 230mm to 460mm
Without Plastic Pot

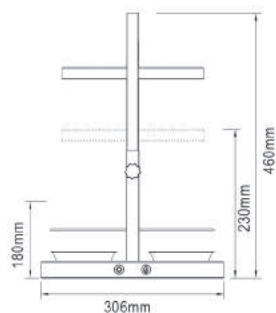

● PNLED-150-2

NEW

2-way LED
PLANT GROW Light
Spike, Pendant



Material: Iron + PMMA + ABS
Lamp: 5W (Red LED + Blue LED + White LED)
3-way Touch Switch: Red + Blue-White-Off
Color: White + Silver
With Push On / Off Switch on Cable
(automatically shut down after 12 hours)
With 1.2m USB Cable

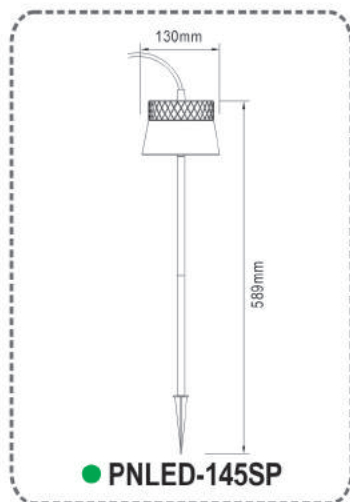

LED PLANT GROW Light with Spike

Material: Iron + ABS + PC
Lamp: 5W (Red LED + Blue LED)
Color: White
With 1.2m USB Cable



● PNLED-142SP



● PNLED-18SP



Material: Iron + PMMA + ABS
Lamp: 3W (Red LED + Blue LED)
Color: White
With 1.2m USB Cable

NEW

NEW

LED FLOOD LIGHT

with IC Driver



Material: Aluminum + Glass
 Voltage: AC100-240V
 Color Temperature: 3000K-6500K
 Color: Black / White
 With 15cm 3 × 1.0MM² Rubber Wire
 With IC Driver
 IP65/IP44(With Sensor)

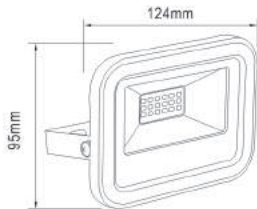

● **FLED-701-10W**

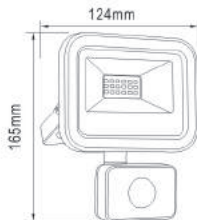

● **FLED-701S-10W**

●	Lamp	Lumen	Product Size(mm)
FLED-701-10	10W(18pcs SMD2835 LED)	800LM	L124 × W95 × H30
FLED-701-20	20W(36pcs SMD2835 LED)	1600LM	L153 × W117 × H33
FLED-701-30	30W(60pcs SMD2835 LED)	2400LM	L185 × W139 × H39
FLED-701-50	50W(100pcs SMD2835 LED)	4000LM	L232 × W175 × H43
FLED-701-100	100W(00pcs SMD2835 LED)	8000LM	L310 × W240 × H44

●	Lamp	Lumen	Product Size(mm)
FLED-701S-10	10W(18pcs SMD2835 LED)	800LM	L124 × W165 × H51
FLED-701S-20	20W(36pcs SMD2835 LED)	1600LM	L153 × W187 × H55
FLED-701S-30	30W(60pcs SMD2835 LED)	2400LM	L185 × W209 × H55
FLED-701S-50	50W(100pcs SMD2835 LED)	4000LM	L232 × W245 × H58
FLED-701S-100	100W(00pcs SMD2835 LED)	8000LM	L241 × W314 × H45

PROMOTION

LED FLOOD LIGHT

with DOB Solution



Material: Aluminum + Glass
 Voltage: AC220-240V
 Color Temperature: 3000K-6500K
 With 15cm 3 × 1.0MM² Rubber Wire
 Color: Black / White
 IP65 / IP44(With Sensor)



●	Lamp	Lumen	Product Size(mm)
FLED-702-10W	10W(15pcs SMD2835 LED)	750LM	L105 × W28 × H77
FLED-702-20W	20W(30pcs SMD2835 LED)	1400LM	L134 × W34 × H98
FLED-702-30W	30W(45pcs SMD2835 LED)	2100LM	L173 × W37 × H126
FLED-702-50W	50W(75pcs SMD2835 LED)	3500LM	L173 × W45 × H126
FLED-702-100W	100W(140pcs SMD2835 LED)	7000LM	L260 × W50 × H189

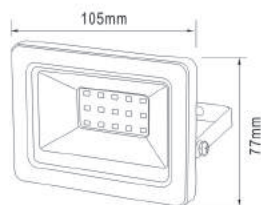

● FLED-702-10W

●	Lamp	Lumen	Product Size(mm)
FLED-702S-10W	10W(15pcs SMD2835 LED)	750LM	L105 × W77 × H136
FLED-702S-20W	20W(30pcs SMD2835 LED)	1400LM	L134 × W56 × H156
FLED-702S-30W	30W(45pcs SMD2835 LED)	2100LM	L173 × W60 × H182
FLED-702S-50W	50W(75pcs SMD2835 LED)	3500LM	L173 × W60 × H182
FLED-702S-100W	100W(140pcs SMD2835 LED)	7000LM	L240 × W71 × H262

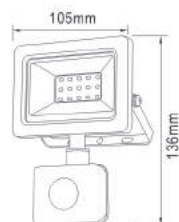

● FLED-702S-10W

LED FLOOD LIGHT

with Junction Box

AC Type



Material: Aluminium + Glass
 Voltage: AC220-240V
 Color Temperature: 3000K-6500K
 Color: Black / White
 With 15cm 3 × 1.0MM² Rubber Wire
 With Junction Box
 IP65 / IP44



Junction Box

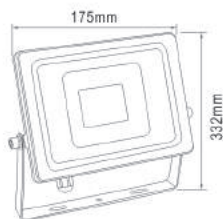

● FLED-735-20W

●	Lamp	Lumen	Product Size(mm)
FLED-735-10W	10W(14pcs SMD2835 LED)	800LM	L105 × W86 × H294
FLED-735-20W	20W(28pcs SMD2835 LED)	1600LM	L175 × W114 × H332
FLED-735-30W	30W(70pcs SMD2835 LED)	2400LM	L213 × W142 × H353
FLED-735-50W	50W(70pcs SMD2835 LED)	4000LM	L241 × W163 × H373

●	Lamp	Lumen	Product Size(mm)
FLED-735S-10W	10W(14pcs SMD2835 LED)	800LM	L138 × W149 × H294
FLED-735S-20W	20W(28pcs SMD2835 LED)	1600LM	L175 × W175 × H332
FLED-735S-30W	30W(70pcs SMD2835 LED)	2400LM	L213 × W203 × H353
FLED-735S-50W	50W(70pcs SMD2835 LED)	4000LM	L241 × W224 × H373

Sensor: 8M; 120°; 8-10Mins

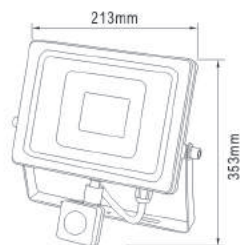

● FLED-735S-30W

LED Exterior WALL LIGHT



Material: Aluminum-Die Cast + Opal PC

Lamp: 6W (2×COB 3W LED)

Lumen: 280LM

Voltage: 220-240V

Finish: White/Black

IP54

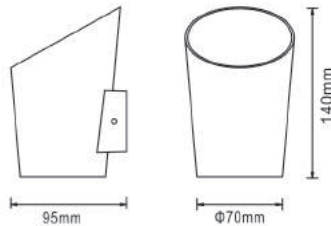

● **ELED-281**

NEW

LED Exterior WALL Light



Material:
Aluminum Die-casting + PC
Voltage: 220-240V / 50Hz
Finish: Black
With Built-in Driver
IP54

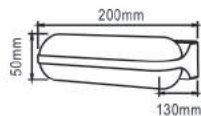

● **ELED-121**
Lamp: 13W SMD LED

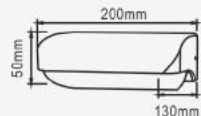

● **ELED-122**
Lamp: 7.5W SMD LED

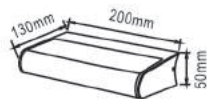

● **ELED-123**
Lamp: 10W SMD LED

NEW

LED Exterior WALL Light



● **ELED-124S**



● **ELED-124**



Material: Aluminum Die-Casting +Opal PC
Voltage: 220-240V, 50Hz
Lamp: 6W SMD 2835 LED
Lumen: 380LM
Finish: Black
IP44

NEW

LED Exterior WALL/PATH Light

PIR Sensor

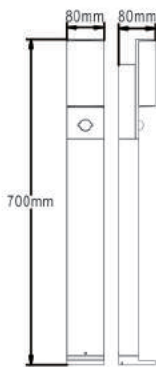
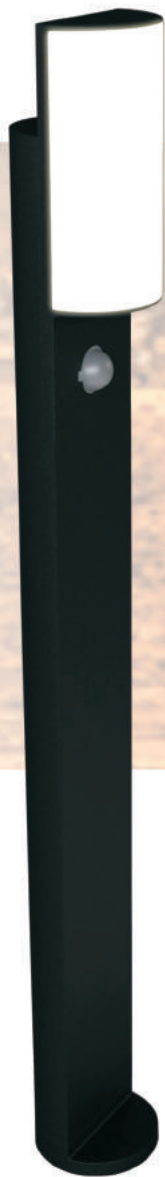

● GPLED-125S

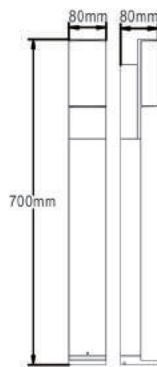

● GPLED-125



NEW



Material: Aluminum Die-Casting + Opal PC
Voltage: 220-240V, 50Hz
Lamp: 8W SMD 2835 LED
Lumen: 600LM
Finish: Black
IP44

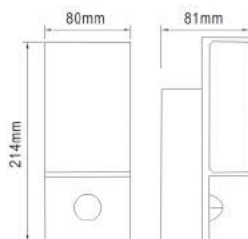
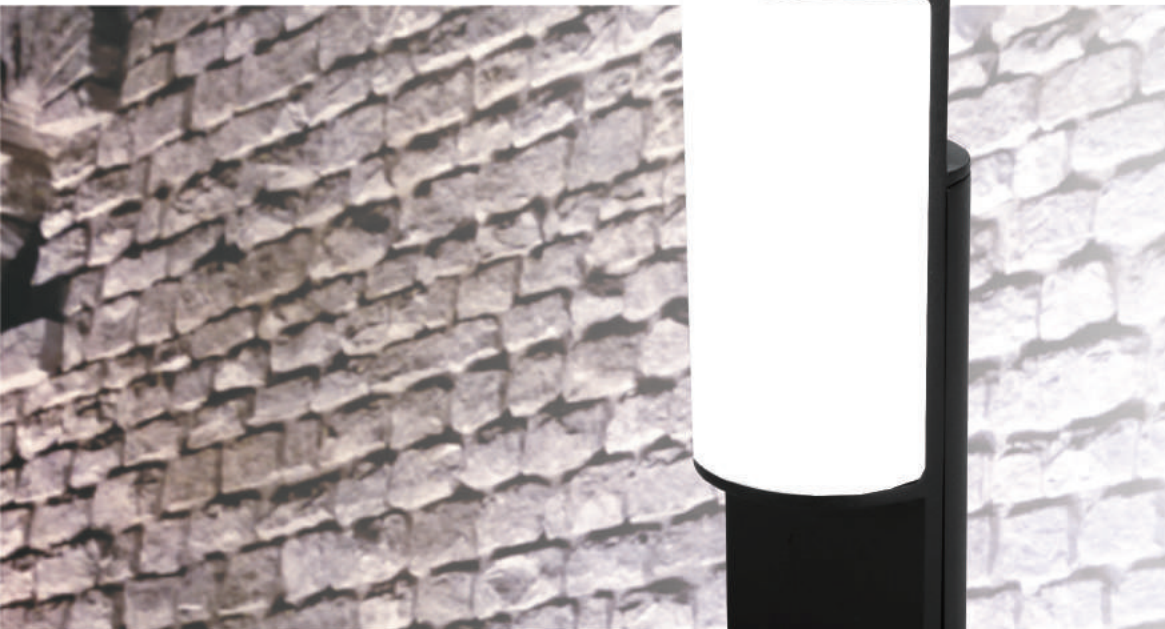

● ELED-125S

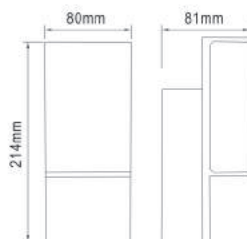

● ELED-125

NEW

Exterior **WALL / PATH** Lantern



Material: Aluminum + Iron + PC
Voltage: 110-240V, 50Hz
Bulb Adapter: E27 60W Bulb
Finish: Black
IP54

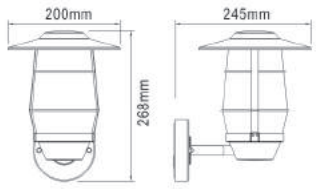

● EL-126



● GPL-126

NEW



Material: ABS Body + Iron&Silicone Tube
Lamp: 3W (22pcs × 0.2W SMD2835 4000K LED)
4-Way Touch Switch: 20%-50%-100%-Off
Battery: 1pc Built-in 1200mAh 18650 Battery
Battery Charging Time: 4-6H
Battery Working Time: 2-8H
Color: White
With 1.2M USB Cable



● TCLED-221

4-way LED **CLIP** Light

PROMOTION

180°

4-way LED PORTABLE Table Lamp

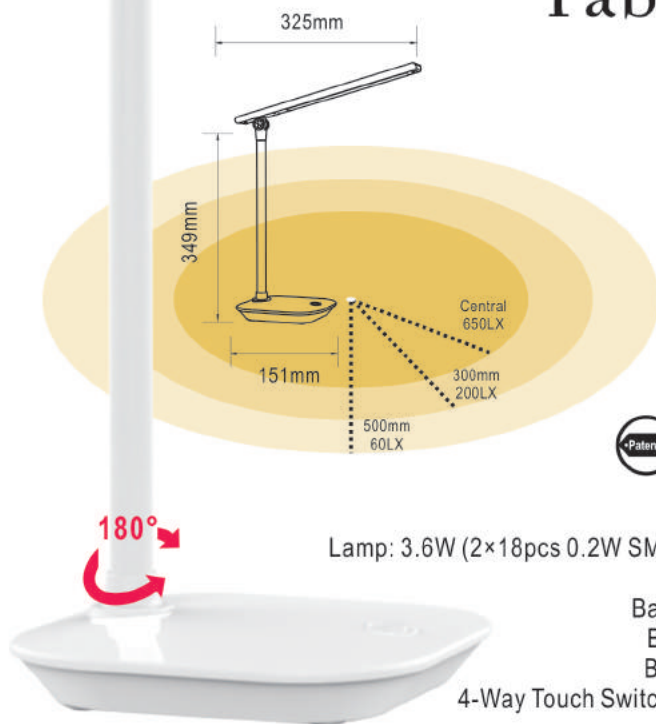

● TLED-113



Material: ABS + Iron + PC
Lamp: 3.6W (2×18pcs 0.2W SMD2835 3000K+6000K LED)
Lumen: 230LM
Battery: 3.7V 1600mAh 18650
Battery Charging Time: 6-8H
Battery Working Time: 4-12H
4-Way Touch Switch: 6000K-3000K-4500K-Off
Color: White / Black
With 1.2m USB Cable

NEW



180°



Material: ABS + Iron + PC
Lamp: 3.6W (2×18pcs 0.2W SMD2835 3000K+6000K LED)
Lumen: 230LM
Battery: 3.7V 1600mAh 18650 Li Rechargeable Battery
Battery Working Time: 4-12H
Battery Charging Time: 8H
4-Way Touch Switch: 3000K-6000K-4500K-Off
Color: White / Black
With 1.2m USB Cable

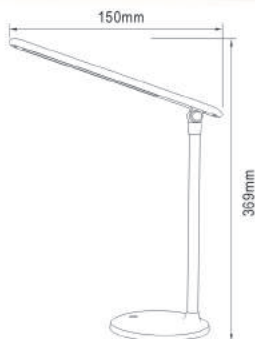

● TLED-114

NEW

LED SMART Table Lamp

180°



Material: ABS + Iron

Lamp: 8W (22pcs 0.2W SMD2835 4000K LED)

With 4-Way Touch Switch: 20%-50%-100%-Off

Color: White

With 1.2m USB Cable

90°



● TLED-120

NEW

Compatible with AMAZON ECHO



Material: ABS + Iron

Lamp: 8W (22pcs 0.2W SMD2835 4000K LED)

With 4-Way Touch Switch: 20%-50%-100%-Off

Color: White

With 1.2m USB Cable

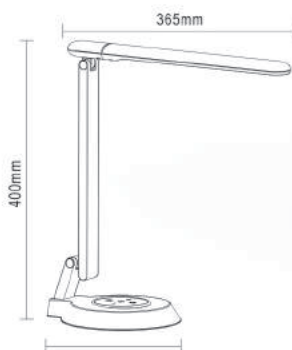

● TLED-121

NEW



LED Interior WALL / READING Light

LED Interior

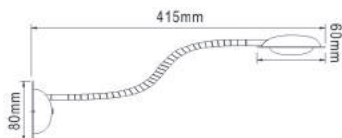

● **WLED-221**



Material: Iron + PMMA
Lamp: 2W (8pcs SMD2835 White LED)
Finish: Satin Nickel
With Built-in Driver
With Toggle Switch on Base

NEW



Material: Iron + ABS
Lamp: 1.5W (SMD2835 LED)
Finish: Satin Nickel
With Built-in Driver
With Toggle Switch on Base

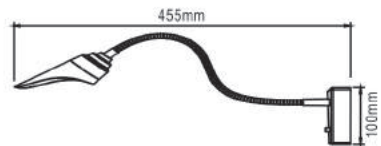

● **WLED-222**

NEW

2-IN-1 LED Interior Wall/Reading Light



Material: Iron + Fabric Lampshade
Lamp: 1.5W White LED(Incl.)
+ E27 14W LED Bulb(Excl.)
Finish: Satin Nickel
With Built-in Driver
With 2 Toggle Switches on Base

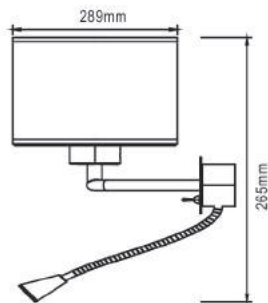

● WLED-224

NEW

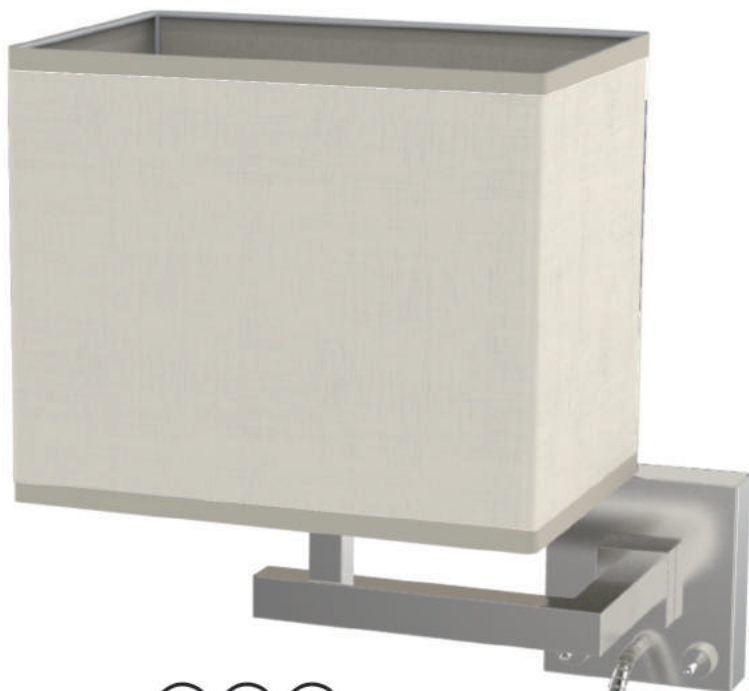

Material: Iron + Zinca Alloy Spot Head
+ Gray Fabric Lampshade
Lamp: 1.5W White LED(Incl.)
+ E27 14W LED Bulb(Excl.)
Finish: Satin Nickel
With 2 Toggle Switches On Base
With Built-in Driver

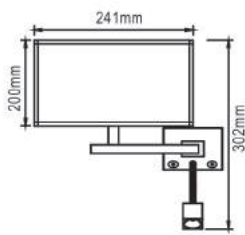

● **WLED-227**

NEW

2-IN-1 LED Interior Wall/Reading Light

with USB Slots



Material: Iron + Aluminum + Fabric
Lamp: 1.5W White LED(Incl.)
+ E27 14W LED Bulb(Excl.)

Finish: Satin Nickel
With 2 Toggle Switches on Base
With Built-in Driver
With 2 USB Slots

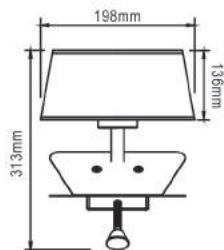

● **WLED-225**

NEW



Material: Iron + Aluminum + Fabric
Lamp: 1.5W White LED(Incl.)
+ E27 14W LED Bulb(Excl.)
Finish: Satin Nickel
With 2 Toggle Switches on Base
With Built-in Driver
With 2 USB Slots

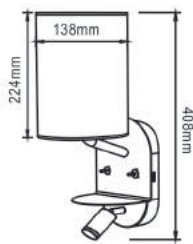

● **WLED-226**

NEW

2-in-1 LED Interior WALL/READING Light

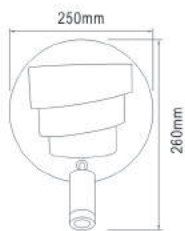

● **WLED-228A**

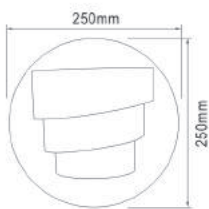

● **WLED-228**

Material: Metal Tube + PP Diffuser
+ Medium Density Fiber Board
Lamp: 4.5W (10pcs SMD5630 LED)
+ Spot 4W (1pc COB LED)
Color: White + Wood Grain
With Toggle Switch on the Base

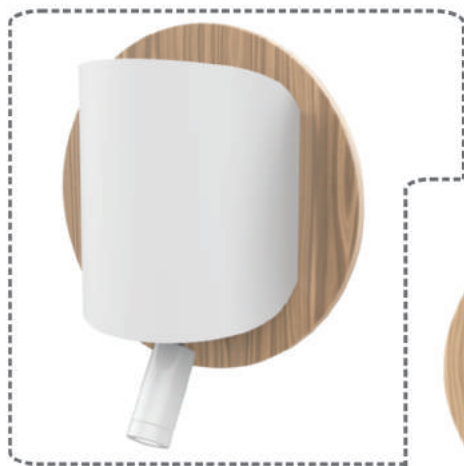

● WLED-229A

● WLED-229



● WLED-230A



● WLED-230



PROMOTION



reddot design award
winner 2008

LED MUSHROOM Lamp



ABS Top & Body + PS Diffuser
Injected Black / White / Blue / Green / Orange / Pink
0.72W (12 × 0.06W F5 LED)
3×AA Battery (Excl.)
60LM (6000K)



● ETLED-18BPT



PROMOTION



Material: ABS Body + PC Diffuser
3-way Slide Switch: Motion Sensor-Off-On
Motion Sensor: 2M; 120°; 18±5 Secs.
Lamp: 2 × 0.5W SMD5630 Modules
Lumen: 25LM (4000K)
Battery: 3 × AAA (Excl.)
Battery Working Time: 8H
Color: White



Easy to Fixed on Wall



● BO-LED74



Battery Operated **SENSOR** Light

BABY Comfort Light

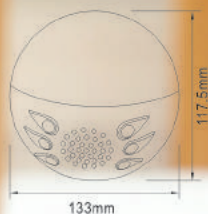

● **BO-LED026**

HOW TO MAKE BABY SLEEP TIGHT? **SOUNDS YOU LIKE!**

The best way to help your baby back to sleep with your own choice of music or song you sing. Auto-activate When Crying!



Color: White

Material: ABS + PC + Silicone

Lamp: 8pcs × 0.2W SMD5050 RGB LED

Power Consumption: 1.5W

With Built-in 3.7V 2000mAh 18650 Battery

Battery Charging Time: 8H, 500 Circles

Battery Working Time: 3H

With 1 pc 1G TF Card

With 3W Bluetooth Speaker

With 1.2m USB Cable

Transformer as Option



Select 1 Mode for Baby Comfort	Mode ① Play Voice or Music Recorded by Button 5 (Max. 30mins + RGB Light)
	Mode ② Music Off, RGB Light Only, 30mins
	Mode ③ Play TF Card Saved Music

Set Up	④ Volume Up
	⑤ Record Music or Voice, Record by the Built-in Microphone
	⑥ Volume Down

Wake Up Light-DAWN

Sunrise Simulation



Material: ABS Body + PC Diffuser + Silicone Button

Lamp: 1.2W(8pcs×0.2W SMD5050 RGB LED
+ 8pcs×0.2W SMD2835 White 3000K LED)

Power: DC 5V, 500mA

Battery: 3 × AAA (Excl.) for Time/Alarm

Battery Working Time: About 3 Months (Standby Mode)

Color: White + Black

Gradually Brightens over 30mins

With 1.2m USB Cable for Light

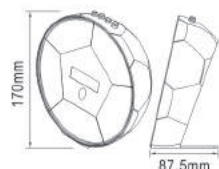

● BO-LED121



Baseball



Functions

- ① MENU
 - Set Time
 - Set Alarm Sound
 - Set Alarm Time
 - Set Alarm Volume (15 Levels)
 - Set Alarm On/Off
- ② UP
- ③ DOWN
- ④ SELECT
 - Fix Time
 - Fix Alarm Sound
 - Fix Alarm Time
 - Fix Alarm Volume
 - Alarm On/Off
- ⑤ Touch On/Off for Time Display (15 Seconds Time Delay)



LED Mood Light-LAUGHTER



Material: ABS Body + PC Diffuser

Lamp: 2.5W (12pcs × 0.2W SMD5050 RGB LED
+ 12pcs × 0.2W SMD2835 White 4000K LED)

Power: 3.2V, 6mA

Battery: 3 × AA (Excl.)

Battery Working Time: >36H

4-way Touch Switch: White Light-RGB-Off

Color: White + Black

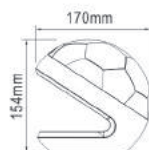

● SPK-B016



Baseball



Helmet



American
Football

LED Mood Light-LAUGHTER

Wireless Charging



Material: ABS Body + PC Diffuser

Lamp: 2.5W (12pcs × 0.2W SMD5050 RGB LED
+ 12pcs × 0.2W SMD2835 White 3000K LED)

3-Way Touch Switch: White Light - RGB Circle - Off

Color: White + Black

With 1.2m Mirco USB Cable

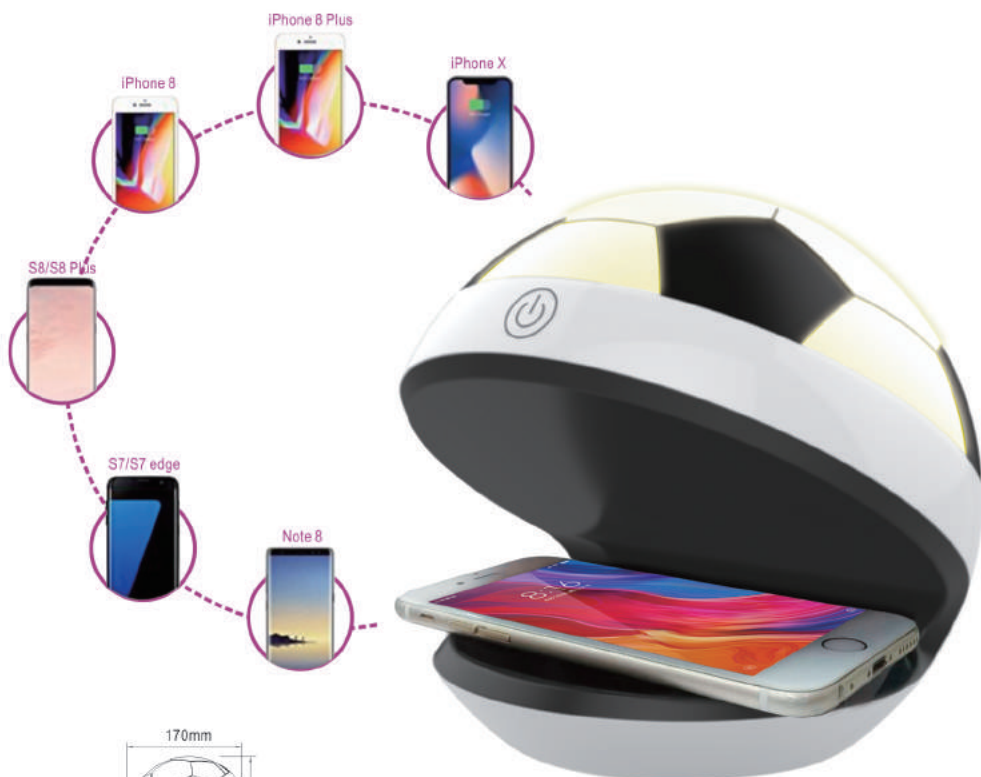

PROMOTION

Material: ABS Body + PC Diffuser
Lamp: 1W (10pcs x 0.1W SMD2835 3000K LED)
Power: 3.2V, 6mA
Battery: 3 x AAA(Excl.)
Battery Working Time: > 24H
Color: White + Black
Touch On/Off Switch



Drawing ROLY-POLY Mood Light



38

Home Resource Ind. Co., Ltd.

● KLED-61A

LED Mood Light-NEON

Roly-poly



Material: ABS Body + Diffuser
Lamp: 1W(10pcs × 0.1W SMD5050 RGB LED
+ 10pcs × 0.1W SMD2835 White 3000K LED)
Power: 4.5V, 6mA
Battery: 3 x AAA(Excl.)
Battery Working Time: > 24H
3-Way Touch Switch for Light: White-RGB-Off
Color: White + Black

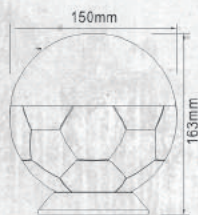

● KLED-61



Baseball

NEW

Mirror Light VENUS



Material: ABS + PC + Iron + Glass
Lamp: 1.8W (30pcs×0.06W SMD2835 6000K LED)
Battery: 1pc Built-in 1200mAh 18650 Battery
Battery Charging Time: 4-6H
Battery Working Time: 2-12H
4-Way Touch Switch: 20%-50%-100%-Off
Color: Light Pink
With 1.2M USB Cable



● MRLED-97



Supply Partner:

We are not only playing the role as a manufacturer but also can implement as a supply partner on your behalf which covers following functions:

- **Quality Control: assurance & conduct inspection**
- **Shipping Control: consolidation of goods & shipment arrangement**
- **Payment Release**
- **Buying Trip Arrangement**

We involve a comprehensive product range covering home lighting, commercial lighting, outdoor lightings, bulbs and tube lights.

If you are in consideration of having someone to act as your supply partner for above function, please do not hesitate to contact Home Resource for further discussion.



▪ Service Team



▪ Inspection & Testing



▪ Shipping & Financial



HOME RESOURCE IND. CO., LTD.
Home Resource LEDS The World

The 30th Home Resource Prize Golf Invitation Tournament
to be held at Agile Golf & Country Club, Zhongshan, China

EXPECT YOUR PARTICIPATION



- **Home Resource Golf Team**
Welcome Your Participation for a Friendly Golf Competition



Please contact us: hr@homerresource.com.tw

SINCE 1988
30th
ANNIVERSARY

Manufacturer • Buying Agent • Inspection Agent



Home Resource Ind. Co., Ltd.

Taipei Headquarter:

4F, No. 69-5, Sec. 2, Chung Cheng East Rd., Tanshui Dist., New Taipei City, Taiwan

China Factory:

No.8, Yanjiang W. 1st Rd., Keji Ave., Torch Development Zone, Zhongshan City, Guangdong, China

Tel: 886-2-2809-1212 (Rep. 12 Lines) Fax: 886-2-2808-1565

E-mail: hr@homeresource.com.tw

<http://www.homeresource.com.tw>



ISO 9001